

**PONTI SOLLEVATORI ELETTROIDRAULICI
A FORBICE PER VEICOLI INDUSTRIALI**

ELECTROHYDRAULIC SCISSOR LIFTS FOR HEAVY VEHICLES
PONTS ELEVATEURS ELECTROHYDRAULIQUES A CISEAUX POUR POIDS LOURDS
ELEKTROHYDRAULISCHE SCHEREN-HEBEBÜHNE FÜR SCHWERE FAHRZEUGE



PONTI SOLLEVATORI ELETTRIDRAULICI A FORBICE PER VEICOLI INDUSTRIALI

ELECTROHYDRAULIC SCISSOR LIFTS FOR HEAVY VEHICLES

TRACCIATO TECNICO COSTRUTTIVO

- Funzionamento elettroidraulico.
- Realizzazione secondo le vigenti normative.
- Comandi "uomo presente". Tensione ausiliaria 24 V.
- Dispositivo acustico e comando a due mani nell'ultima fase di discesa.
- Valvola di sicurezza contro i sovraccarichi.
- Valvola di sicurezza su ogni cilindro contro la lesione o la rottura dei tubi.
- Controllo con valvola compensata della velocità di discesa.
- **Dispositivo elettronico per il controllo ed il costante mantenimento del parallelismo delle due pedane, indipendentemente dalla distribuzione del carico. Il sistema di parallelismo viene controllato da PLC.**
- Fotocellula di sicurezza per la posizione delle due pedane.
- Dispositivo apposito per il controllo e l'effettuazione dello stazionamento delle due pedane.
- Possibilità di posizionamento della centrale di comando secondo le necessità.
- Olio per circuito idraulico in dotazione.
- Tasselli di ancoraggio al suolo in dotazione.

TECHNICAL AND STRUCTURAL LAY-OUT

- Electro-hydraulic operating.
- Built in conformity with the european normative laws in force.
- "Man standing-by" controls. Auxiliary tension 24 V.
- Sound device and two hand control during the last descent phase.
- Safety-valve against overloads.
- Safety-valve on each cylinder against damage or breackage of pipes.
- Check through a valve adjusting the descent speed.
- **Electronic device for the check and constant keeping of the parallelism of the two platforms independently from the load distribution. System of parallelism is checked by PLC.**
- Safety photocell for the position of the two platforms.
- Special device for the check and the execution of the standing of the two platforms.
- Possibility to install the control-box according to the necessities.
- Delivered with oil for the hydraulic circuit.
- Equipped with anchor small blocks.



PONTS ELEVATEURS ELECTROHYDRAULIQUES A CISEAUX POUR POIDS LOURDS

ELEKTROHYDRAULISCHE SCHEREN-HE- BEBÜHNE FÜR SCHWERE FAHRZEUGE

RELEVÉ TECHNIQUE

- Fonctionnement électrohydraulique.
- Réalisation selon les lois en vigueur.
- Commande "homme mort". Tension auxiliaire 24 V.
- Dispositif sonore et commande à deux mains dans la dernière phase de descente.
- Vanne de sécurité anti-surcharges.
- Vanne de sécurité sur chaque cylindre pour éviter l'endommagement ou la rupture des tuyaux.
- Vanne de compensation de la vitesse de descente.
- **Dispositif électronique pour le contrôle et le constant maintien du parallélisme des deux chemins de roulements, indépendamment de la distribution de la charge. Le système de parallélisme est contrôlé par PLC.**
- Capteurs de sécurité pour le positionnement des deux chemins de roulements.
- Dispositif de paramétrage du stationnement des chemins de roulement.
- Possibilité de positionner la centrale de commande selon les besoins.
- Livrés avec l'huile pour le circuit hydraulique.
- Chevilles d'ancrage au sol fournies.

TECHNISCHE UND KONSTRUKTIVE ANGABEN

- Elektrohydraulischer Betrieb.
- Herstellung unter Berücksichtigung der gültigen Europäischen Normen.
- "Stand-by-Steuerung". Steuerspannung 24 V.
- Akustisches Signal und Zweihand-Steuerung während der letzten Absenkphase.
- Sicherheitsventil als Überlastungsschutz.
- Sicherheitsventil auf jedem Zylinder für die Überwachung der Druckleitungen.
- Sicherheitsventil zur Kontrolle der Absenkgeschwindigkeit.
- **Elektronische Vorrichtung zur Überwachung und ständige Gewährleistung der Fahrschienausrichtung, unabhängig von der Lastenverteilung. Elektronische Gleichlaufüberwachung (PLC).**
- Sicherheitsphotozelle zur Überwachung der Fahrschieneinstellung.
- Vorrichtung zur Überwachung und Sicherung der Fahrschienen in die gewünschte Arbeitsstellung.
- Das Steuerpult kann beliebig aufgestellt werden.
- Wird mit Öl für die hydraulische Schaltung geliefert.
- Ausgestattet mit schmaler Grundplatte.





**9
TON** **13
TON** **23
TON** **33
TON**



ART. 902

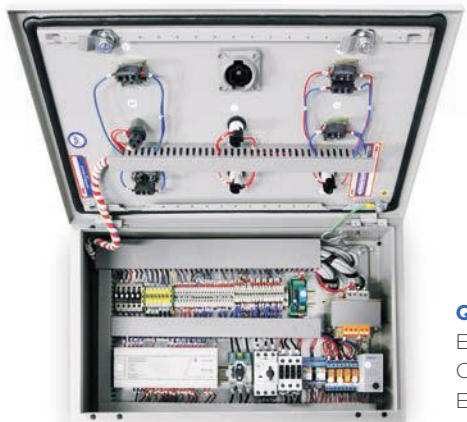

QUADRO ELETTRICO DI COMANDO
Electric control board
Cadre électrique de commande
Elektrische Steuerschalttafel



UNITÀ IDRAULICA DI COMANDO
Control hydraulic unit
Unité hydraulique de commande
Hydraulische Überwachungseinheit



Modello a pavimento
Floored model
Modèle au sol
Überflur-Modell

Modello a scomparsa
Disappearing model
Modèle encastrable
Unterflur-Modell

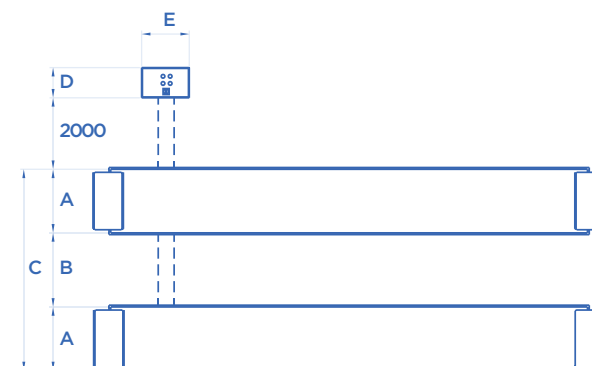
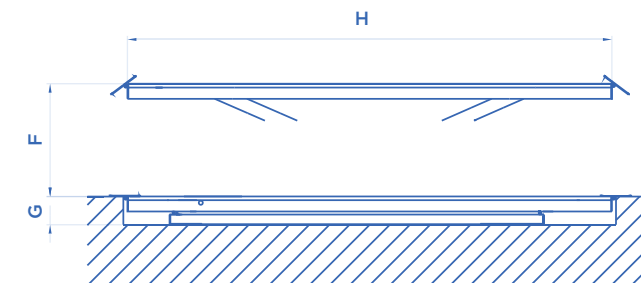
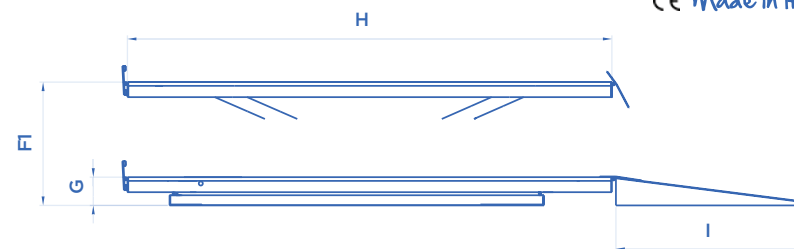

ART. 910/SM

OPTIONAL Pag. 124

 Potenza motore • Motor power • Puissance moteur • Motorleistung

ART.			Motore trifase Three-phase motor Moteur triphasé Netzspannung	A mm	B mm	C mm	D mm	E mm	F mm	F1 mm	G mm	H mm	I mm		
900	9000 Kg	5,5 KW	400V • 50HZ	780	1100	2660	450	600		1900		6000	2700	4850	
910	9000 Kg	5,5 KW		780	1100	2660	450	600	1510				6000		4250
910/SM	9000 Kg	5,5 KW		780	*	*	450	600	1510				4600		4000
901	13000 Kg	7,5 KW		780	1100	2660	450	600			1900		7000	2700	5600
911	13000 Kg	7,5 KW		780	1100	2660	450	600	1510			390	7000		5000
902	23000 Kg	8,8 KW		780	1100	2660	450	600			1900		8000	2700	7950
912	23000 Kg	8,8 KW		780	1100	2660	450	600	1510				8000		7350
903	33000 Kg	15 KW		780	1100	2660	580	800			1900		9000	2700	10600
913	33000 Kg	15 KW		780	1100	2660	580	800	1510				9000		10000



26
TON

46
TON





60
TON

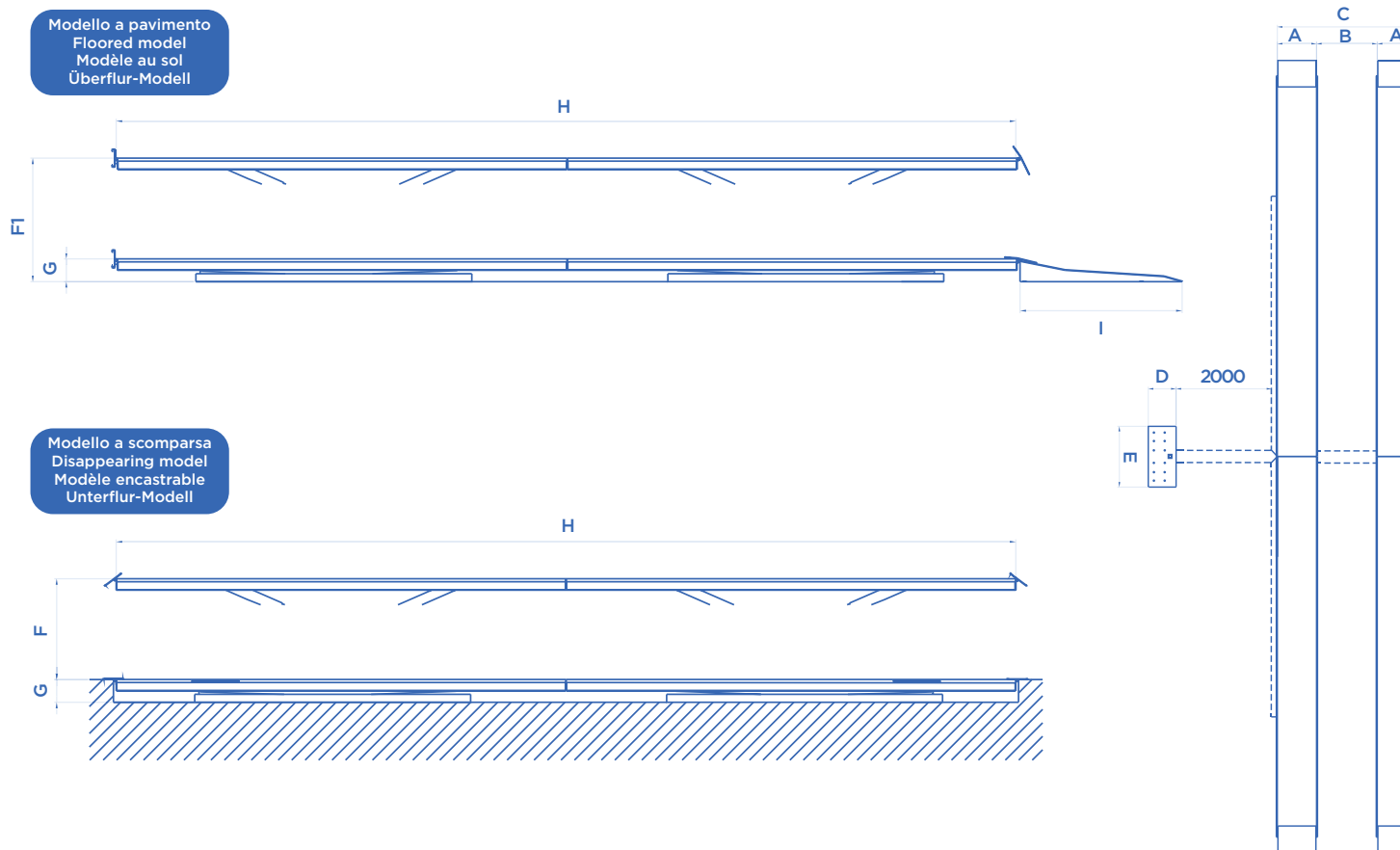

ART. 907



OPTIONAL Pag. 124

ART.			Motore trifase Three-phase motor Moteur triphasé Netzspannung	A  mm	B  mm	C  mm	D  mm	E  mm	F  mm	F1  mm	G  mm	H  mm	I  mm	 KG
906	26000 Kg	2x7,5 KW	400V • 50HZ	780	1100	2660	650	1200	1510	1900	390	14000	2700	10600
916	26000 Kg	2x7,5 KW		780	1100	2660	650			14000		10000		
907	46000 Kg	2x8,8 KW		780	1100	2660	650			16000		2700	15300	
917	46000 Kg	2x8,8 KW		780	1100	2660	650			16000		14700		
908	60000 Kg	2x15 KW		780	1100	2660	650			16500		2700	20600	
918	60000 Kg	2x15 KW		780	1100	2660	650			16500		20000		

 Potenza motore • Motor power • Puissance moteur • Motorleistung



ART. 912+912

Questa soluzione prevede l'installazione fisica di due sollevatori il cui funzionamento, a discrezione dell'operatore, può essere:

SIMULTANEO: le quattro pedane dei due ponti si sollevano in modo perfettamente sincronizzato per poter operare su mezzi molto lunghi.

INDIPENDENTE: i due sollevatori funzionano in modo indipendente l'uno dall'altro, garantendo la possibilità di operare in contemporanea su due veicoli differenti.

This solution entails the physical installation of two lifts with two different modes of operation, which can be chosen at the operators own discretion:

SIMULTANEOUS: all four footboards of both lifts move together in a perfectly synchronous movement, allowing you to operate on long vehicles.

INDEPENDENT: both lifts operate independently, allowing you to operate on two different vehicles at the same time.

Cette solution prévoit l'installation physique de deux élévateurs pour deux configurations de travail différentes, au choix de l'opérateur:

SIMULTANÉE: les quatre chemins de roulement des deux élévateurs se lèvent de manière parfaitement synchronisée pour pouvoir intervenir sur des véhicules très longs.









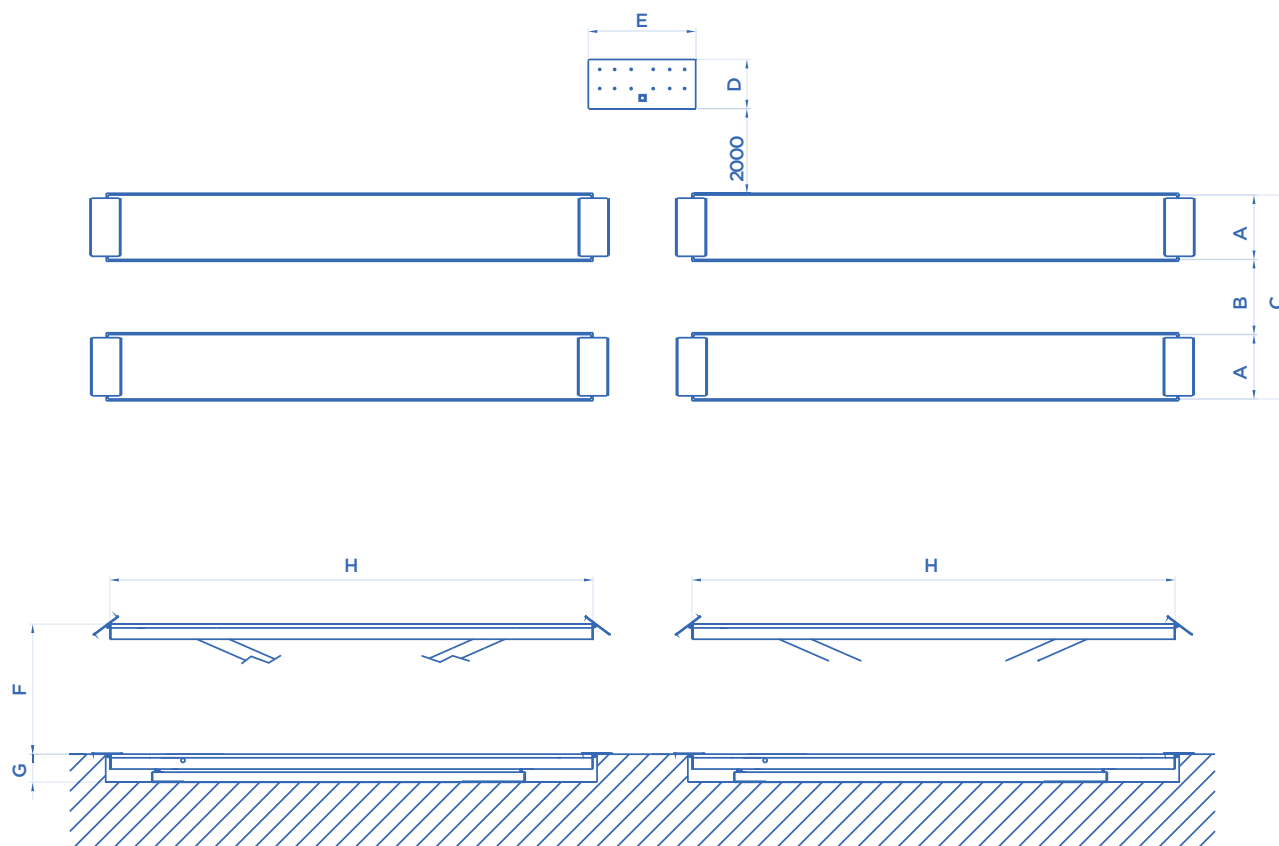

INDÉPENDANTE: les deux élévateurs fonctionnent indépendamment l'un de l'autre. Il est possible de travailler sur deux véhicules différents en même temps.

Diese Lösung beinhaltet den physischen Einbau von zwei Hebebühnen, deren Betriebsweise kann nach eigenem Ermessen des Betreibers ausgewählt sein:

SIMULTAN: die vier Fahrschienen der zwei Hebebühnen erheben sich vollständig synchronisch, um mit sehr langen Fahrzeugen arbeiten zu können.

UNABHÄNGIG: die zwei Hebebühnen funktionieren unabhängig voneinander, um mit zwei verschiedenen Fahrzeugen gleichzeitig arbeiten zu können.



ART.			Motore trifase Three-phase motor Moteur triphasé Netzspannung	A 	B 	C 	D 	E 	F 	G 	H 	
910+910	9000+9000 Kg	2x5,5 KW	400V • 50HZ	780	1100	2660	650	1200	1510	390	6000	8500
911+911	13000+13000 Kg	2x7,5 KW		780	1100	2660	650		1510	390	7000	10000
912+912	23000+23000 Kg	2x8,8 KW		780	1100	2660	650		1510	390	8000	14700
913+913	33000+33000 Kg	2x15 KW		780	1100	2660	650		1510	390	9000	20000

OPTIONAL Pag. 124

ACCESSORI EXTRA DOTAZIONE

EXTRA EQUIPMENT • ACCESSOIRES EN OPTION • EXTRA ZUBEHÖR

KIT **X2**

ART. 920 KIT PER LA SALITA E DISCESA PARTE ANTERIORE

Up and down kit - front side
Kit pour la montée et descente partie antérieure
2 Überfahrtschienen (vorn)

L = 2.700 mm.



IMPIANTO DI ILLUMINAZIONE A LED

Led lighting system
Kit d'éclairage led
LED Beleuchtungsanlage



ART. 923 ✓ H = 4600 • 6000 mm
ART. 923/A ✓ H = 7000 • 8000 • 9000 mm



ART. 926 INCAVO PREDISPOSTO SULLE PEDANE PER L'ALLOGGIAMENTO DEL PROVA GIOCHI IDRAULICO

Cavity on the footboards for housing of play-testing device
Cavité prédisposée sur les chemins de roulement pour l'encastrement des plaques à jeux
Aussparungen im vorderen Teil der Fahrschienen, um eine Gelenkspiel-Testvorrichtung aufzunehmen

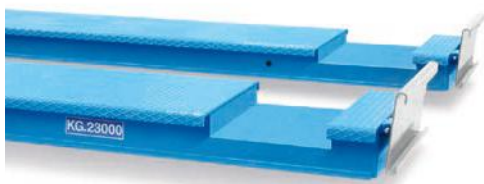

PROLUNGHE DI COLLEGAMENTO TRA IL SOLLEVATORE E LA CENTRALINA DI COMANDO (1 m)

Connection extensions between the hoist and the control box
Rallonges de jonction entre l'élévateur et le pupitre de commande
Verlängerungsschläuche (zwischen Hebebühne und Steuerpult)



ART. 922 ✓ ART. 900 • 901 • 902 • 910 • 911 • 912
ART. 922/A ✓ ART. 903 • 913
ART. 922/B ✓ ART. 906 • 916
ART. 922/C ✓ ART. 907 • 917
ART. 922/D ✓ ART. 908 • 918

TELAI PER INCASSO

Embedding frames
Caissons pour modèles encastrables
Metallrahmen für Grube



ART. 921 ✓ ART. 910 • 910/SM • 911 • 912
ART. 921/A ✓ ART. 913
ART. 921/B ✓ ART. 916 • 917
ART. 921/C ✓ ART. 918