







# Ravaglioli

COMPANY WITH  
QUALITY SYSTEM  
CERTIFIED BY DNV GL  
= ISO 9001 =

- DUE COLONNE ELETTROIDRAULICI 
- ELECTRO-HYDRAULIC 2 POST LIFTS 
- ELEKTROHYDRAULISCHE 2-SÄULEN HEBEBÜHNEN 
- 2 COLONNES ELECTRO-HYDRAULIQUES 
- DOS COLUMNAS ELECTRO-HYDRAULICOS 

KPH

370.55

LIK T

LIK TA

370.70

LIK T

LIK TA



*For long wheel-base vehicles  
5500 kg - 7000 kg*



SINCE 1958





**KPH370.55LIKT / 5500 kg**  
**KPH370.70LIKT / 7000 kg**

Modello equipaggiato con 4 bracci extra lunghi a tre stadi: ideali per il sollevamento di furgoni e furgonati a passo lungo incluso Mercedes Sprinter e VW Crafter.

*Model equipped with four extra long three-stage arms: ideal to lift long wheel-base vans like Mercedes Sprinter and VW Crafter.*

Modell mit vier zweifach ausziehbaren extra langen Armen ausgestattet: ideal zum Heben von Lieferwagen auch mit langem Radstand wie Mercedes Sprinter and VW Crafter.

*Élévateur équipé de quatre bras extra longs à 3 étages: idéal pour le levage de fourgons à châssis long inclus les Mercedes Sprinter and VW Crafter.*

Modelo equipado con 4 brazos extra largos de tres extensiones: ideal sea para el levantamiento de furgonetas normales y de chasis largo incluido Mercedes Sprinter and VW Crafter.

**KPH370.55LIKTA / 5500 kg**  
**KPH370.70LIKTA / 7000 kg**

Versioni con due bracci lunghi a 3 stadi e due a 4 stadi, consentono caricabilità ottimale anche per le autovetture.

*Models equipped with two long 3-stage arms and two long 4-stage arms, to allow easy lifting of large cars.*

Ausführungen mit zwei zweifach und zwei dreifach ausziehbaren langer Armen, um eine optimale Aufnahme von PKWs auch zu garantieren.

Versiones équipées de deux bras longs à 3 étages et deux à 4 étages pour garantir aussi le levage optimal de voitures.

Versiones con dos brazos largos de 3 extensiones y dos de 4 extensiones, por el levantamiento tambien de turismos.

Dispositivo di appoggio meccanico ad inserimento automatico a garanzia della massima sicurezza in fase di stazionamento.

*Mechanical safety latch with automatic engagement ensuring maximum safety when lift is in standing position.*

Mechanische Stützvorrichtung mit automatischer Einschaltung um eine maximale Sicherheit im aufgehobenen Zustand zu garantieren.

*Dispositif de soutien mécanique avec enclenchement automatique pour garantir la sécurité totale pendant le stationnement.*

Dispositivo de apoyo mecánico de funcionamiento automático como garantía de la máxima seguridad en la fase de estacionamiento.

I cavi non portanti garantiscono la sincronizzazione.

*Synchronization cables grant the levelling of the two carriages.*

Gleichlauf mittels Seile (nicht tragend).

*La synchronisation est garantie grace à un cable d'acier non-portant.*

Los cables no portantes garantizan la sincronización.

In ciascuna colonna è presente un pistone di sollevamento che non richiede alcuna manutenzione.

*Each column features a maintenance-free lifting cylinder.*

Wartungsfreie Zylinder in jeder Säule.

*Chaque colonne est équipée d'un vérin conçu pour un fonctionnement "sans entretien.*

En cada columna está presente un pistón de elevación que no requiere mantenimiento alguno.



Altezza regolabile  
Adjustable height  
Justierbare Höhe  
Hauteur réglable  
Altura regulable

**KPH370.55LIKT/LIKTA**

4950 mm  
4850 mm

**KPH370.70LIKT/LIKTA**

5016 mm  
4816 mm  
4616 mm

**VARKPH370.55LIKT/T - VARKPH370.55LIKTA/T**  
**VARKPH370.70LIKT/T - VARKPH370.70LIKTA/T**

Versione a richiesta con:  
Version on demand featuring:  
Version auf Anfrage:  
Version sur demande avec:  
Versión bajo pedido con:

**1**

Comando singolo per salita/discesa  
Single lifting/lowering control  
Drehwendschalter zum Hoch- und Runterfahren  
Commande unique pour montée-descente  
Mando individual para bajada/subida

**2**

Sgancio arresti pneumatico  
Pneumatic release of locking devices  
Pneumatische Entriegelung  
Décrochage pneumatique des arrêts  
Desenganche neumático de los trinquetes de seguridad

**3**

Centralina in alto  
Control unit on the upper part of the column  
Hydraulikaggregat oben  
Unité hydraulique en haut  
Centralita posicionada en la parte alta de la columna

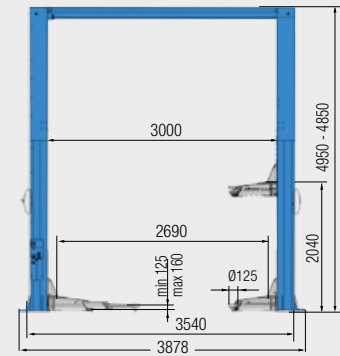

**KPH370.55LIKT**

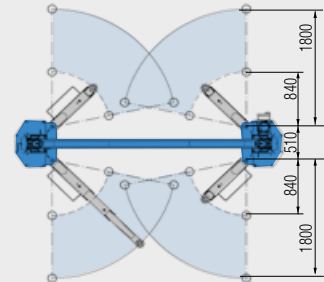

**KPH370.55LIKTA**

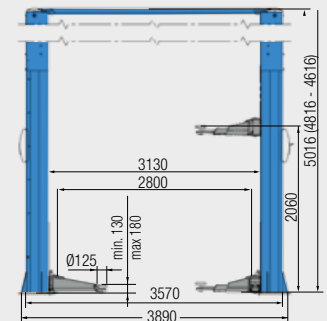
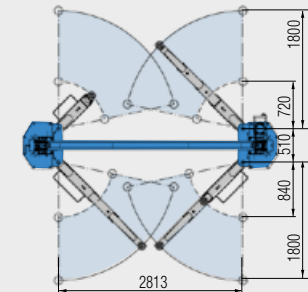

**KPH370.70LIKT**

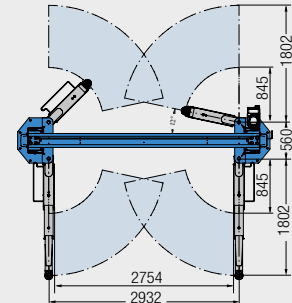

**KPH370.70LIKTA**

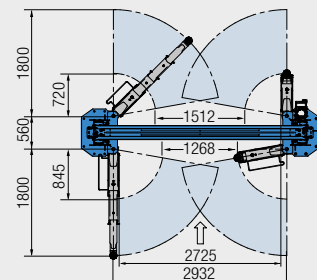



## OPTIONS

**S370A7**

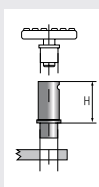

H=80mm  
4xkit



**S370A8**



H=140mm  
4xkit



**S370A15**



H=200mm  
4xkit



Distanziali / Spacers / Abstandstücke / Rehausses / Espesores



**Quick fit system**

**S370A16** → S370A7 - S370A8 - S370A15  
Ø 60mm

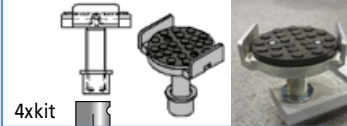

4xkit

Supporti presa telaio  
Frame adapters  
Halierungen für  
Chassisaufnahme  
Supports prise sur  
chassis  
Espesores de agarre  
sobre chasis



**S5.337 A2** 2xkit  
Supporti presa telaio  
Frame adapters  
Halierungen für Chassisaufnahme  
Supports prise sur chassis  
Espesores de agarre sobre chasis



**S370A9 Ø 60mm** 2xkit  
Kit supporto distanziali  
Spacer supports  
Satz Halterung Distanzhülsen  
Supports pour rehausses  
Soportes para espesores

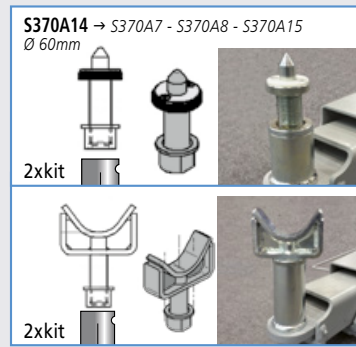
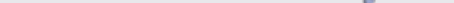

**S370A14** → S370A7 - S370A8 - S370A15  
Ø 60mm



2xkit

**For Mercedes Sprinter,  
VW LT+Crafter**  
Supporti  
Adapters  
Halierungen  
Supports  
Adaptadores de agarre

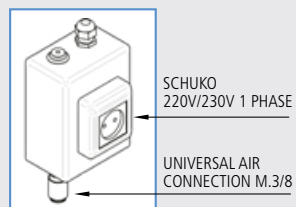

**S374A2**  
1 PHASE + AIR  
Air / Electric utility box

SCHUKO  
220V/230V 1 PHASE  
UNIVERSAL AIR  
CONNECTION M.3/8

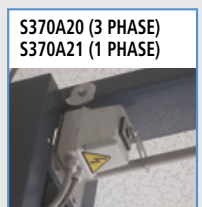

**S370A20 (3 PHASE)**  
**S370A21 (1 PHASE)**

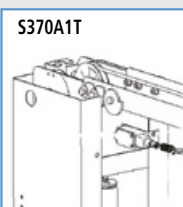

**S370A1T**

Finecorsa  
Limit switch  
Endabschalter  
Fin de course  
Final de carrera

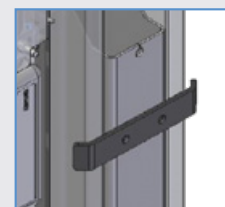

**S370A5 2xkit**  
Set parasportelli  
Set of door protections  
Satz Türanschläge  
Kit protection portes  
Juego de protecciones  
para puertas.



**Ravaglioli S.p.A.**

via 1° maggio 3  
Fraz. Pontecchio M.  
40037 Sasso Marconi (Bo) - Italia  
Tel. +39 - 051 - 6781511  
Fax +39 - 051 - 846349  
rav@ravaglioli.com  
www.ravaglioli.com

**RAV France**

4, Rue Longue Raie  
ZAC de la Tremblaie  
91220 Le Pleissis Pâté  
Tel. 01.60.86.88.16  
Fax 01.60.86.82.04  
rav@ravfrance.fr

**Ravaglioli Deutschland**

Kirchenpoint 22  
85354 Freising  
Tel. 08165-646956  
Fax 08165-646958  
ravd@ravaglioli.com

**RAV Equipment UK LTD**

Prince Albert House  
20 King Street  
Maidenhead, SL6 1DT  
Tel. +39 - 0516781522  
rav@ravaglioli.com

**RAV en Belgique**

Nederlandstalig  
Tel. 0498-162016  
Fax 016-781025  
Zone Francophone  
Tel. 0498-163016  
Fax +32 78 055 030

**RAV Equipos España S.L.U.**

Avenida Europa 17  
Pol. Ind. de Constanti  
Tarragona 43120  
Tel. 977 524525  
Fax 977 524532  
ravequipos@ravaglioli.e.telefonica.net



DRD21U (07)

Le caratteristiche tecniche e gli allestimenti presentati in questo prospetto possono subire variazioni. Le immagini riprodotte non sono vincolanti.  
Technical data and composition presented in this catalogue may vary. Pictures reproduced are only indicative.  
Die techn. Daten und die Ausrüstungen, die in diesem Prospekt enthalten sind, können Änderungen erfahren. Deshalb sind die Abbildungen unverbindlich.  
Les caractéristiques techniques et les compositions présentées dans ce prospectus peuvent subir des variations. Les images reproduites n'ont qu'une valeur indicative.  
Las características técnicas y las composiciones ilustradas en este folleto pueden sufrir variaciones. Las imágenes propuestas son solamente indicativas.

